



Eldex



Eldex® Optos Metering Pumps Operator's Manual



Eldex Laboratories, Inc.
30 Executive Court
Napa, CA 94558
Tel: (707) 224-8800
Fax: (707) 224-0688
www.eldex.com

TABLE OF CONTENTS

CONTENTS	PAGE
I. INTRODUCTION	1
Optos Metering Pumps	1
Principles of Operation	1
Materials of Construction	1
About This Manual	1
A Guided Tour of Optos Metering Pumps	2
Specifications	6
Stainless Steel Pump Specifications	6
PEEK Pump Specifications	7
II. INSTALLATION	8
What You Will Need	8
The Unit	8
Tools	8
Unpacking and Location	8
Electrical Connections	8
Power Entry Module	8
Inputs/Outputs	8
Plumbing	9
Solvent Preparation	9
Attaching Inlet Tubing	10
Priming The Pump	10
Attaching Outlet Tubing	10
Pulse Damper Use	10
Using the Piston Wash System	10
III. OPERATION	12
Basic Operation	12
General Notes on Software Operation	12
Setting the Flow Rate	12
Setting the High Pressure Limit	12
Setting the Low Pressure Limit	12
Configuration Screens	13
Setting the Compressibility Compensation Factor	13
Sending the Piston to the Home Position	13
Changing the Refill Rate Setup	13
Setting the Liquid End Type	13
Setting the Remote Control Setting	14
Viewing the EPROM Revision Level	14

Advanced Screens	14
Setting the Home Position Offset	14
Setting the Output Function	15
Setting the High/Low Pressure Limit Shutdown	15
Setting the Motor Stall Shutdown	15
Viewing the Stroke Length	16
Zeroing the Pressure Transducer	16
Pump Limits	17
Viscosity Limits	17
Chemical Limits	17
Mechanical Limits	17
Temperature Limits	17
Shutdown Procedures	17
IV. MAINTENANCE	18
Cleaning	18
Piston Seals	18
Replacing The Piston Seal	18
Replacing Valves	20
Removal Of Existing Valves	20
Installation Of New Valves	20
Replacing Valve Cartridges	20
Troubleshooting	21
V. SPARE PARTS AND ACCESSORIES	22
For 3/32" Stainless Steel Pumps	22
For 1/8" Stainless Steel Pumps	23
For 1/4" Stainless Steel Pumps	24
For 3/32" PEEK Pumps	25
For 1/8" PEEK Pumps	26
For 1/4" PEEK Pumps	27
VI. APPENDIX	28
RS232	28
Warranty	29
Return Procedure	29
Trademarks	29

	CAUTION: The exclamation point within an equilateral triangle is intended to alert the user to the presence of important operating and maintenance (servicing) instructions in the literature accompanying the appliance.
	ATTENTION: Le point d'exclamation dans un triangle équilatéral signale à alerter l'utilisateur qu'il y a des instructions d'opération et d'entretien très importantes dans la littérature qui accompagne l'appareil.
	ACHTUNG: Ein Ausrufungszeichen innerhalb eines gleichwinkligen Dreiecks dient dazu, den Benutzer auf wichtige Bedienungs- und Wartungsanweisungen in der dem Gerät beiliegenden Literatur aufmerksam zu machen.

	<p>CAUTION: We have tested this pump with 2 propanol. Residual amounts of 2 propanol may be in the pump. You may wish to flush with an appropriate, miscible solvent.</p> <p>You may be using a variety of fluids which require special handling procedures and safety precautions. Consult the appropriate MSDS (Material Safety Data Sheet) supplied with the materials you will be using. Be certain to follow all handling, safety, and disposal procedures appropriate for the materials you use.</p>
	<p>ATTENTION: Gardez à l'esprit que nous avons testé cette pompe avec le propanol-2. Les quantités résiduelles du propanol-2 peuvent se trouver sur le dispositif de raccordement du liquide et vous souhaitez certainement les chasser avec un solvant miscible approprié.</p> <p>Vous pouvez utiliser une variété de liquides qui nécessitent des manipulations et des précautions particulières. Consultez la fiche technique de sécurité appropriée; elle est fournie avec le matériel que vous utiliserez. Veillez à bien respecter toutes les procédures de manipulation, sécurité et élimination du matériel.</p>
	<p>ACHTUNG: Die Pumpe wurde mit 2-Propanol getestet. Geringe Restmengen von 2-Propanol können sich noch im System befindend, so dass wir Ihnen vor Inbetriebnahme das Spülen mit einem geeigneten Lösungsmittel empfehlen.</p> <p>Sie können eine Vielzahl von Lösungsmitteln einsetzen, deren Verwendung unter Umständen spezielle Sicherheitsvorkehrungen voraussetzt. Bitte beachten Sie in allen Fällen die, den Lösungsmitteln vom Hersteller beigelegten Sicherheitsdatenblätter.</p>

INTRODUCTION

Laboratory and industrial procedures often require metering precise amounts of fluids in a controlled and reproducible manner. Optos pumps were developed in response to this need. These pumps are capable of delivering measured amounts of fluids against significant backpressure.

Pump Features Include:

- Piston wash chamber for backflushing piston to extend seal life.
- Electronic control of piston motion to minimize pulsation.
- Optional pulse damper for further pulse reduction.
- Easy to use interface for flow setting and other pump parameters.
- Metal-free options

Principles of Operation

Optos pumps attain precise metering at intermediate and high pressures by a positive displacement, reciprocating piston. The piston is driven by a stepper motor via an eccentric. Advanced software algorithms control motor speed based on piston position, achieving rapid fluid intake and smooth, constant fluid delivery, minimizing pulsation. Additional reductions of pulsation can be achieved by use of the optional damper.

Ball and seat inlet and outlet valves ensure precise metering. The suction created by the piston retracting to refill the piston chamber pulls the inlet ball off the inlet seat allowing fluid to travel through the inlet check valve. Simultaneously, the outlet ball is pulled back onto its' seat, preventing fluid from exiting the piston chamber. During the delivery portion of the piston's duty cycle, the inlet ball is pushed back onto its' seat as the piston moves forward, preventing fluid from travelling back to the pump reservoir. Simultaneously, the outlet ball is forced off its' seat, allowing fluid to exit the outlet valve. For the valves to operate effectively, a pressure differential of at least 25 psi is required on the outlet side of the pump.

The pump's flow rate is set directly in mL/min. using the up and down buttons on the user interface. Flow rates are determined by piston displacement (diameter, and stroke length) and motor speed.

Some Optos pumps may be fitted with a pulse damper. The damper is a diaphragm type damper, where a diaphragm made of an inert material flexes against a compressible fluid (spiked with red dye), thereby absorbing pulses in fluid delivery. To maximize the damper's efficiency, the system should operate against at least 500 psi. If your system does not normally generate such pressures and you wish to increase the efficiency of the damper, you can install a backpressure device, or some narrow ID tubing downstream of the pump.

Materials of Construction

The materials used for the liquid end of your Optos Pump were carefully chosen for corrosion resistance. The piston is sapphire, and the inlet and outlet valves incorporate sapphire seats and ruby balls.

The piston seal material is made from specially formulated PTFE and has excellent chemical compatibility characteristics.

The liquid end housing is made of passivated type 316 stainless steel because of its superior resistance to corrosion. In applications requiring the use of chemicals corrosive to type 316 stainless steel, you may order a PEEK (polyetheretherketone) liquid end.

About This Manual

This manual provides instructions and information on Optos metering pumps.

Section II of this manual, beginning on page 8, describes the unpacking, location, and initial installation of your metering pump. Section III, beginning on page 11, describes the operation of the Optos hardware and the menu system in detail.. Section IV, beginning on page 16, describes maintenance procedures. Section V, beginning on page 20, contains appendixes, including, lists spare parts and accessories for the various pump models.

A Guided Tour of the Optos Metering Pumps

Front Panel

As you look at the front panel of your Optos Metering Pump (Figure 1.1), you will see:

Component Details

Local Interface:

1. **Liquid Crystal Display (LCD).** Displays flow rate, pressure (with optional pulse damper), other allowed functions.
2. **Up/Down Keys.** UP and DOWN arrow keys set flow rates, change pump settings.
3. **Permanent Functions Keys.** DISPLAY, ΔMENU, and RUN/STOP keys are control keys permanently defined for direct control of major instrument functions.
4. **Status LEDs.** Indicate pump running or fault.

Pulse Damper: optional pulse damper for minimized fluid delivery pulsation.

5. **Outlet Port:** Connection to downstream device.
6. **Inlet Port:** Connection from pump outlet.

Liquid End Assembly:

7. **Outlet Valve:** Provides tubing connection for pump output.
8. **Cylinder:** Contains pumping chamber and piston wash ports.
9. **Inlet Valve:** Provides tubing connection to fluid source. Inlet valve has an additional groove on the hexagonal portion of the valve.

Rear Panel

As you look at the rear panel of your Optos Metering Pump (Figure 1.2), you will see:

Component Details

1. **RS232:** RJ11 connector for RS232 communication.
2. **I/O:** Input/output connections for remote analog control, pressure out, error out, remote start, stop.
3. **Power Entry:** Provides power connection with modular cord.
4. **Fuse:** Housing for pump fuses.
5. **On/Off:** Turns the power to the pump on and off.

Figure 1.1: Front View of Optos

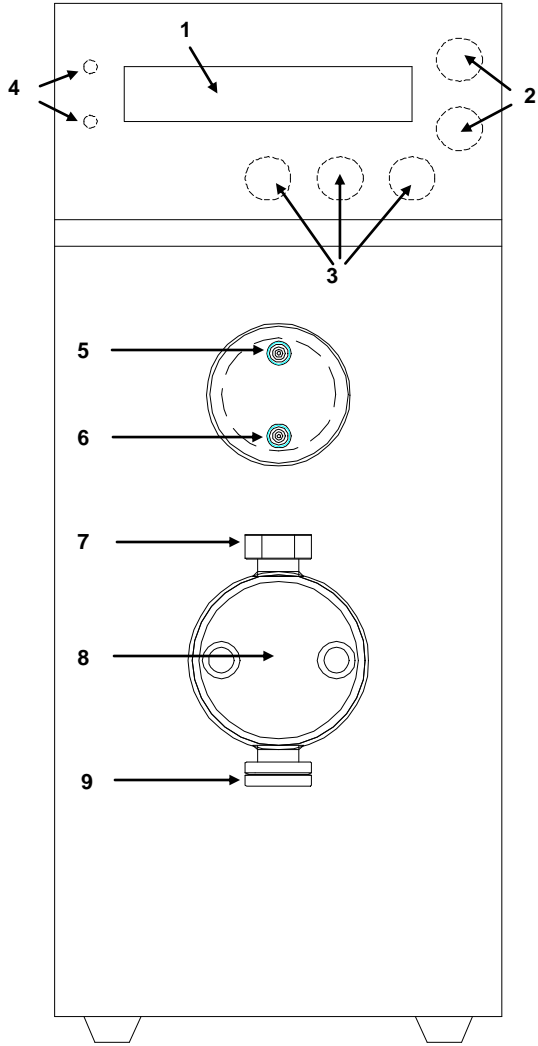
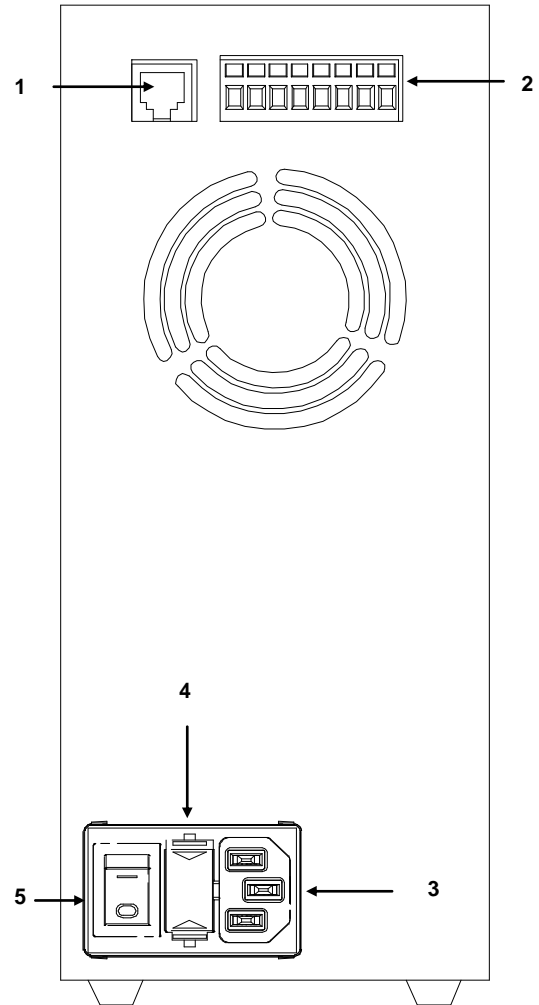

Figure 1.2: Rear View of Optos



An Overall Look at the Local Interface

Operation of the Optos Pump is controlled from a series of menus and there is no need to remember esoteric control codes or command sequences. A detailed description of the menu sequence is given in Section III.

As you look at the local interface (Figure 1.3), you will see:

Component Details

1. **Status LEDs:** Upper green LED indicates pump is running; lower red LED indicates a pump fault (for example, an overpressure limit, or motor stall condition).
2. **Display:** A one line, 16 character LCD display is used to provide readout of flow and pressure (with optional pulse damper), and access to pump functions.
3. **Up/Down Keys:** UP and DOWN arrow keys set flow rates, pressure limits (with optional pulse damper), and function settings.
4. **Permanent Function Keys:** ΔMENU key changes the display to different pump functions, DISPLAY key toggles display back to main display of flow, or flow and pressure (with optional pulse damper), RUN/STOP key runs the pump and stops the pump.

Key Definitions

ΔMENU: The ΔMENU (Change Menu) key scrolls through the main menu selections.

DISPLAY: The DISPLAY key toggles back to main display of flow, or flow and pressure (with optional pulse damper).

UP/DOWN: UP and DOWN arrow keys increase or decrease flow rate setting, high or low pressure limit settings, and change setting of other pump parameters.

DISPLAY, then ΔMENU: Holding down the DISPLAY key followed by pressing the ΔMENU key brings up a series of sub menus which pertain to various pump settings. Pressing the DISPLAY key alone returns to main display.

ΔMENU, then DISPLAY: Holding down the ΔMENU followed by pressing the DISPLAY key brings up a series of sub menus which pertain to obscure pump settings. Pressing the DISPLAY key alone returns to main display.

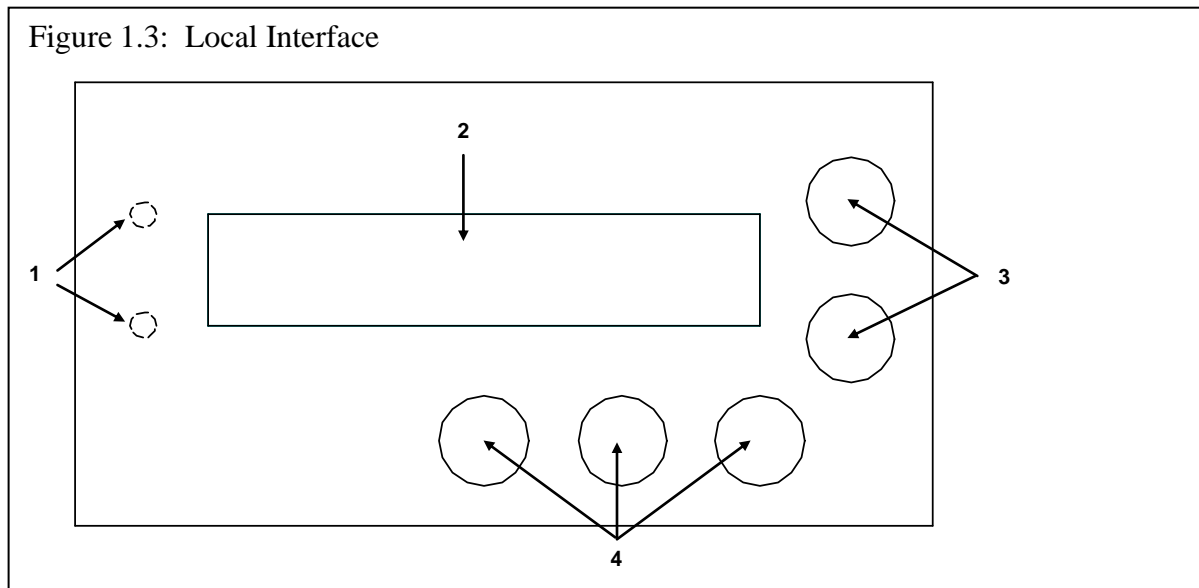

Menu Schematic

The menu schematic indicates the general structure of the menu map. The specific screens shown may vary from your specific configuration.

Basic Screens

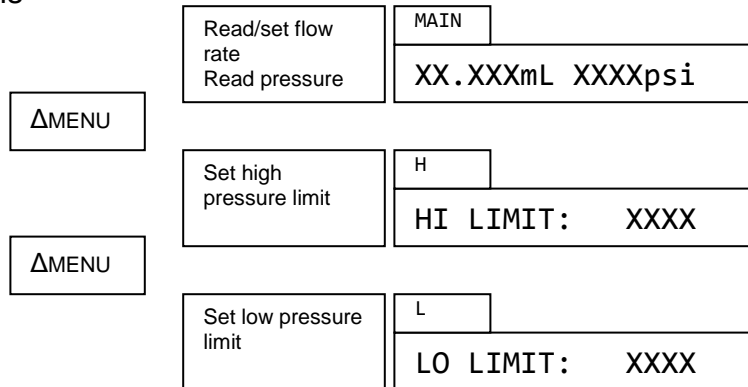

Configuration Screens: DISPLAY & ΔMENU

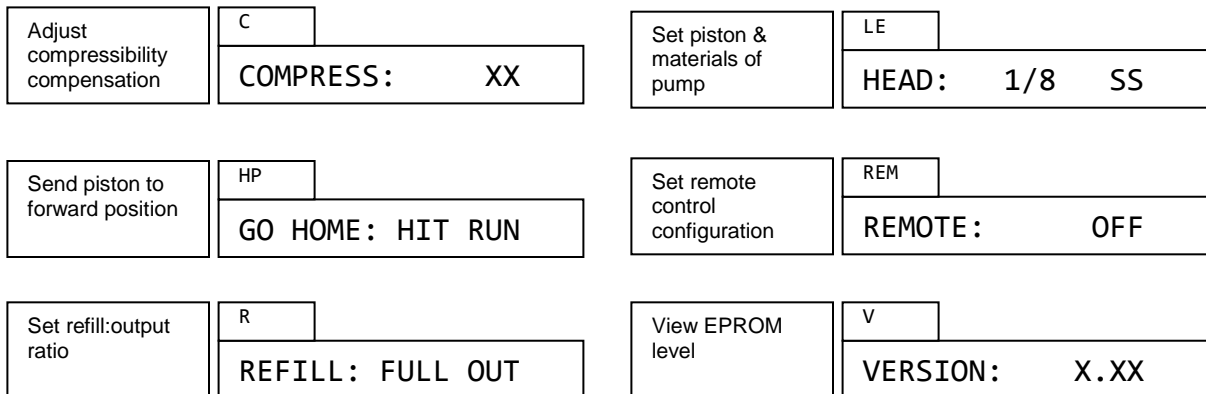

Advanced Screens: ΔMENU & DISPLAY

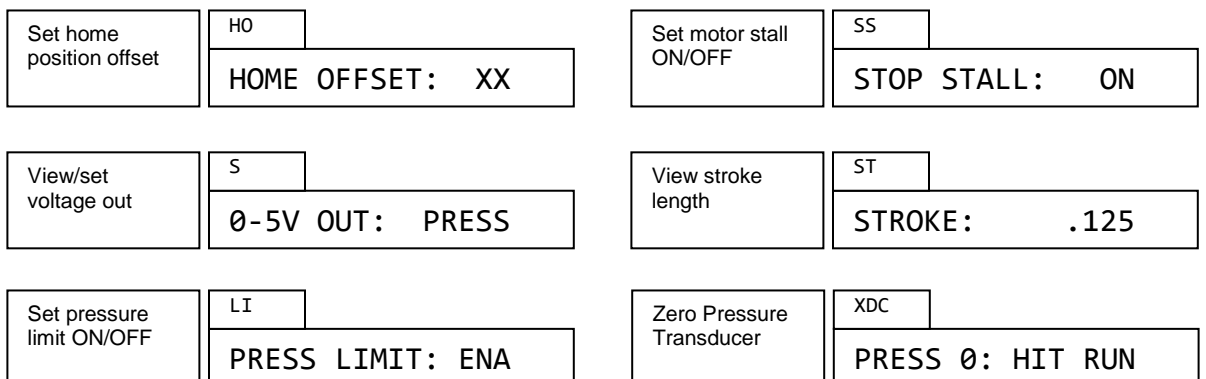

Specifications

Stainless Steel Optos/Model 1 Pump Specifications

Model	Flow Rate Range (min.to max.) mL/min.	Max Pressure (psi)	Piston Diameter (inches)	Max. Piston Stroke	Piston Displacement	Electrical	VA	Dimensions (L x W x H inches)	Weight (lbs.)
1LM	0.002 - 2.5	6000	.093	.125"	.014 mL	100-230V; 50/60Hz	80	9.5 x 4 x 9	12
1LMP	0.002 - 2.5	6000	.093	.125"	.014 mL	100-230V; 50/60Hz	80	9.5 x 4 x 9	12
1SM	0.003 - 5.0	6000	.125	.125"	.025 mL	100-230V; 50/60Hz	80	9.5 x 4 x 9	12
1SMP	0.003 - 5.0	6000	.125	.125"	.025 mL	100-230V; 50/60Hz	80	9.5 x 4 x 9	12
1HM	0.01 - 20.0	3000	.250	.125"	.1 mL	100-230V; 50/60Hz	80	9.5 x 4 x 9	12

Stainless Steel Optos/Model 2 Pump Specifications

Model	Flow Rate Range (min.to max.) mL/min.	Max Pressure (psi)	Piston Diameter (inches)	Max. Piston Stroke	Piston Displacement	Electrical	VA	Dimensions (L x W x H inches)	Weight (lbs.)
2LM	0.003 - 5.0	6000	.093	.250"	.028 mL	100-230V; 50/60Hz	80	9.5 x 4 x 9	12
2LMP	0.003 - 5.0	6000	.093	.250"	.028 mL	100-230V; 50/60Hz	80	9.5 x 4 x 9	12
2SM	0.01 - 10.0	6000	.125	.250"	.05 mL	100-230V; 50/60Hz	80	9.5 x 4 x 9	12
2SMP	0.01 - 10.0	6000	.125	.250"	.05 mL	100-230V; 50/60Hz	80	9.5 x 4 x 9	12
2HM	0.02 - 40.0	1500	.250	.250"	.2 mL	100-230V; 50/60Hz	80	9.5 x 4 x 9	12

Stainless Steel Optos/Model 3 Pump Specifications

Model	Flow Rate Range (min.to max.) mL/min.	Max Pressure (psi)	Piston Diameter (inches)	Max. Piston Stroke	Piston Displacement	Electrical	VA	Dimensions (L x W x H inches)	Weight (lbs.)
3LM	0.01 - 10.0	3000	.093	.500"	.057 mL	100-230V; 50/60Hz	80	9.5 x 4 x 9	12
3SM	0.01 - 20.0	1500	.125	.500"	.1 mL	100-230V; 50/60Hz	80	9.5 x 4 x 9	12
3HM	0.04 - 80.0	750	.250	.500"	.4 mL	100-230V; 50/60Hz	80	9.5 x 4 x 9	12

Maximum flow rate specifications are based on the theoretical volume displacement; actual flow rates will vary depending on such factors as fluid viscosity, compressibility, and temperature.

Common Specifications:

Wetted Parts:	Type 316 stainless steel, PTFE, CTFE, sapphire, ruby
Reproducibility:	±0.3% typical
Tubing Connections:	Inlet valve: ¼" –28 plastic fitting for 1/8" Teflon® tubing Outlet valve: 1/16" I.D. ferrule and tube nut, 10-32 thread Pumps with .250" pistons use 1/8" Swagelok connections on the inlet and outlet valves Other connections available on request
Viscosity Limit:	500 Centipoise
Fuses:	.63 A
Operating Environment:	
Temperature:	5 – 35°C
Maximum Humidity:	85%, non-condensing
Maximum Altitude:	2,000 meters
Optional Damper	
Type:	Diaphragm
Wetted Parts:	Type 316 stainless steel, Kalrez

PEEK Optos/Model 1 Pump Specifications

Model	Flow Rate Range (min.to max.) mL/min.	Max Pressure (psi)	Piston Diameter (inches)	Max. Piston Stroke	Piston Displacement	Electrical	VA	Dimensions (L x W x H inches)	Weight (lbs.)
1LI	0.002 - 2.5	4000	.093	.125"	.014 mL	100-230V; 50/60Hz	80	9.5 x 4 x 9	12
1LIP	0.002 - 2.5	4000	.093	.125"	.014 mL	100-230V; 50/60Hz	80	9.5 x 4 x 9	12
1SI	0.003 - 5.0	4000	.125	.125"	.025 mL	100-230V; 50/60Hz	80	9.5 x 4 x 9	12
1SIP	0.003 - 5.0	4000	.125	.125"	.025 mL	100-230V; 50/60Hz	80	9.5 x 4 x 9	12
1HI	0.01 - 20.0	3000	.250	.125"	.1 mL	100-230V; 50/60Hz	80	9.5 x 4 x 9	12

PEEK Optos/Model 2 Pump Specifications

Model	Flow Rate Range (min.to max.) mL/min.	Max Pressure (psi)	Piston Diameter (inches)	Max. Piston Stroke	Piston Displacement	Electrical	VA	Dimensions (L x W x H inches)	Weight (lbs.)
2LI	0.003 - 5.0	4000	.093	.250"	.028 mL	100-230V; 50/60Hz	80	9.5 x 4 x 9	12
2LIP	0.003 - 5.0	4000	.093	.250"	.028 mL	100-230V; 50/60Hz	80	9.5 x 4 x 9	12
2SI	0.01 - 10.0	4000	.125	.250"	.05 mL	100-230V; 50/60Hz	80	9.5 x 4 x 9	12
2SIP	0.01 - 10.0	4000	.125	.250"	.05 mL	100-230V; 50/60Hz	80	9.5 x 4 x 9	12
2HI	0.02 - 40.0	1500	.250	.250"	.2 mL	100-230V; 50/60Hz	80	9.5 x 4 x 9	12

PEEK Optos/Model 3 Pump Specifications

Model	Flow Rate Range (min.to max.) mL/min.	Max Pressure (psi)	Piston Diameter (inches)	Max. Piston Stroke	Piston Displacement	Electrical	VA	Dimensions (L x W x H inches)	Weight (lbs.)
3LI	0.01 - 10.0	3000	.093	.500"	.057 mL	100-230V; 50/60Hz	80	9.5 x 4 x 9	12
3SI	0.01 - 20.0	1500	.125	.500"	.1 mL	100-230V; 50/60Hz	80	9.5 x 4 x 9	12
3HI	0.04 - 80.0	750	.250	.500"	.4 mL	100-230V; 50/60Hz	80	9.5 x 4 x 9	12

Maximum flow rate specifications are based on the theoretical volume displacement; actual flow rates will vary depending on such factors as fluid viscosity, compressibility, and temperature.

Common Specifications:

Wetted Parts:	PEEK, UHMW Polyethylene, CTFE, sapphire, ruby
Reproducibility:	±0.3% typical
Tubing Connections:	Inlet valve: ¼" –28 plastic fitting for 1/8" Teflon® tubing Outlet valve: 1/16" I.D. ferrule and tube nut, 10-32 thread Other connections available on request
Viscosity Limit:	500 Centipoise
Fuses:	.63 A
Operating Environment:	
Temperature:	5 – 35°C
Maximum Humidity:	85%, non-condensing
Maximum Altitude:	2,000 meters
Optional Damper	
Type:	Diaphragm
Wetted Parts:	PEEK, Kalrez

INSTALLATION

What You Will Need

The Unit

A Optos Pump consists of the pump assembly, a fittings kit for tubing connections (except for 1/4" piston stainless steel pumps, which have fittings attached to the valves), a syringe (except 1/4" pumps), a power cord, this manual and warranty card.

Tools

You will not need special tools for the routine use of your OptosPump. For installation, all you will need are a few wrenches to attach the fittings and perhaps a small blade screwdriver if you are making I/O connections. The tool sizes you will need will depend on the specific fittings used (and are referenced in the appropriate section of the instruction manual). If you have not already ordered a Preventive Maintenance Kit, we suggest you consider doing so now. A listing of the various PM Kits beings on page 17.

Unpacking and Location

Before attempting to operate your pump, unpack it carefully. You should not discard any packing material, as you will want to re-use it for storage and shipping. If any damage is evident from improper handling from shipping, you should contact the freight company that delivered the unit to file a claim.

	<p>CAUTION: We have tested this pump with 2 propanol. Residual amounts of 2 propanol may be in the pump. You may wish to flush with an appropriate, miscible solvent.</p> <p>You may be using a variety of fluids which require special handling procedures and safety precautions. Consult the appropriate MSDS (Material Safety Data Sheet) supplied with the materials you will be using. Be certain to follow all handling, safety, and disposal procedures appropriate for the materials you use.</p>
---	---

You must use your Optos Pump in a clean, well ventilated and dust free environment, free of corrosive or explosive vapors. Optos Pumps are designed for table top use; you should not install your pump on the floor. Your Optos Pump must be operated in a horizontal position. Safety may be impaired if use of your Optos pump is not as instructed.

Electrical Connections

Power Entry Module

As you look at the Power Entry Module (Figure 2.1), you will see:

1. **ON/OFF Switch**
2. **Fuse Drawer**
3. **Power Inlet**
4. **Fuses**

The power entry module is self selecting for voltage within the range of 100-240V. The power cord (a 110/115V cord is provided) is plugged into the power inlet. Plug the power cord of the pump into a grounded, properly rated outlet and turn the power switch to ON. The power is turned on by positioning the ON/OFF switch so the "1" is depressed. After you have confirmed there is electrical power, turn the power off by positioning the ON/OFF switch so the "0" is depressed.

Inputs/Outputs

I/O functions are available on the connector on the rear panel. To wire the I/O connector for inputs or outputs, use a small screwdriver to depress the lever in the upper port of the I/O

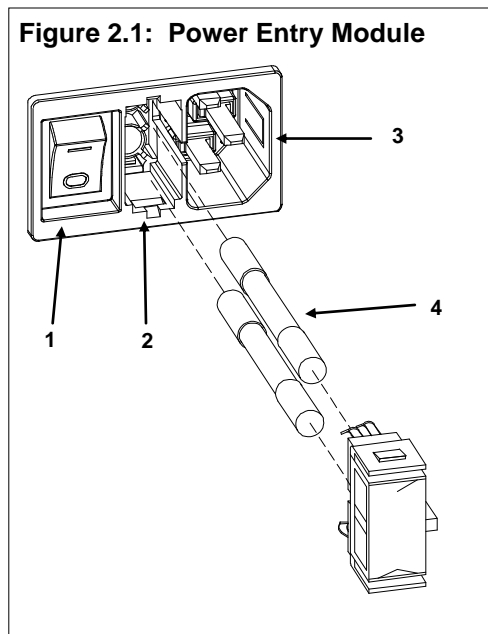

connector; this will open the lower port of the I/O connector. Insert the wire (strip wires by between 1/8" to 1/4") and release the upper port lever.

Inputs

The Optos can be remotely controlled from devices which can send current loop or voltage signals. In addition, the Optos can be remotely controlled using contact closures. The remote inputs available are defined in Table 2.1:

I/O Position	Label	Function	Description
1	4-20mA	4-20mA current loop	Allows for remote control of flow rate using a 4-20mA current loop. Wire signal to position 1 and common to position 2.
2	Common	Common	Used in conjunction with position 1.
3	5VDC	5 VDC	Allows for remote control of flow rate using a 0-5VDC control. Wire signal to position 3 and common to position 5.
5	GND	Ground	Ground position for use in conjunction with position 3, 6 or position 7.
6	RUN	Run pump	Contact closure, starts running pump at set flow rate.
7	STOP	Stop pump	Contact closure, stops pump.

Outputs

The Optos can send contact closures and an analog signal to remote devices. The remote outputs available are defined in Table 2.2:

I/O Position	Label	Function	Description
4	PRESS	Output of pressure	0-5 VDC output of pressure (when optional damper is installed), or flow. Signal output is on position 4; use with ground on position 5.
5	GND	Ground	Used in conjunction with position 4 or position 8.
8	ERROR	Error output	TTL low output indicating pump error (pressure limit violation when used with optional damper; motor stall). Signal output is on position 8; use with ground on position 5.

RS232

The RJ11 connector on the rear panel provides an RS232 communication port. For details on use of the RS232, consult Section V.

Plumbing

Solvent Preparation

Solvent Degassing

We strongly recommend you degass the fluid prior to using it to prevent cavitation. There are many means of degassing the fluid, including ultrasonication and vacuum systems. Many users find helium sparging convenient and effective. The usual procedure is to sparge the solvent vigorously for 15 minutes or so and then maintain a

trickle of helium during solvent use. Some users blanket the reservoir with helium after sparging (pressurize reservoirs to about 3 psi with helium).

Solvent Filtration

You must filter your solvents. We recommend you install a 10 micron sintered stainless steel filter (P/N 5776) on the inlet line. When you wish to avoid metal, a 10 micron plastic filter is available (P/N 1279).

Attaching Inlet Tubing

Most Optos pumps come supplied with a fittings kit, which includes inlet tubing, as well as inlet and outlet nuts and ferrules. Attach the 1/8" Teflon tubing to the inlet valve. Hand tighten the nut onto the valve.

Optos stainless steel pumps with 1/4" diameter pistons use 1/8" Swagelok® fittings on the inlet and outlet valves and use 1/8" tubing (not supplied) and require a 7/16" wrench to tighten the fittings and a 1/2" wrench to tighten the valves.

Priming the Pump

After you attach the inlet tubing to the pump, place the other end of the tubing in a reservoir of the liquid you will be pumping. Be certain you completely submerge the end of the tubing (or the filter) in the liquid. Insert the syringe into the outlet (top) valve opening. You should exercise care when handling the syringe. Improper use can cause the syringe to break off in the valve (and you will have to install a new valve).

Turn the power switch to ON, set a flow rate (usually, for priming, an elevated flow is desirable) and press the run key. Manually draw a few milliliters of fluid into the syringe. Remove the syringe and look at the valve opening. There should not be traces of air bubbles. If the air bubbles persist, turn off the pump, check the liquid level in the reservoir and the tightness of the inlet fitting. If the inlet tubing is above the surface of the liquid, or if the inlet fitting is loose, you will need to correct the condition and repeat the priming procedure. When the pump is primed, press the stop key.

Attach Outlet Tubing to Pump (if required)

With a 1/4" wrench, attach 1/16" tubing (not supplied) to the outlet (top) valve using the tube nut and ferrule. Do not set the ferrule in the valve, since doing so may compress and damage the valve components. Instead, set the ferrule onto the tubing in a column or similar non-compressible fixture. Always stabilize the valve housing with a 1/2" wrench when attaching fittings. Never tighten fittings to beyond 40 in./lbs., or the point where no leakage occurs. Excessive force in tightening fittings can result in valve compression and damage. On PEEK® pumps, the fitting on the outlet valve is hand tightened.

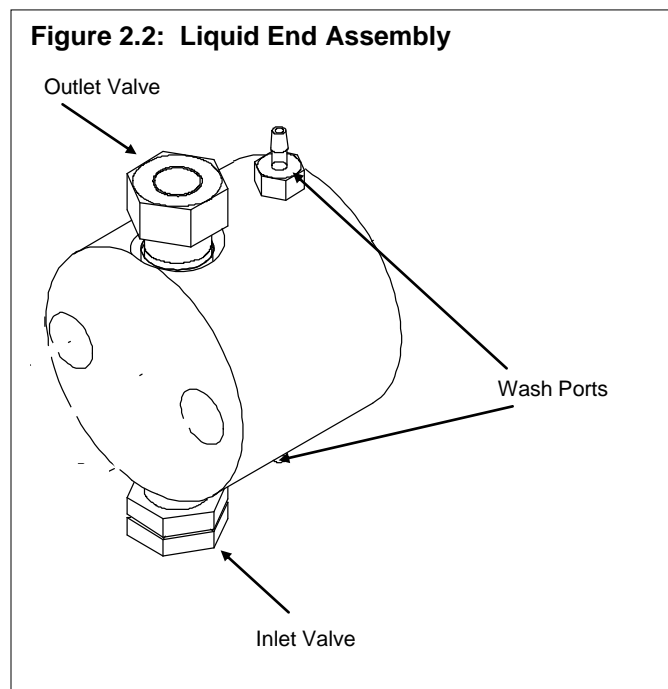

Optos stainless steel pumps with 1/4" pistons use 1/8" Swagelok® fittings on the inlet and outlet valves and use 1/8" tubing (not supplied) and require a 7/16" wrench to tighten the fittings and a 1/2" wrench to tight the valves.

Pulse Damper Use (optional damper on Optos pumps with .093 or .125 pistons)

Optos pumps provided with a pulse damper have a line already connected between the pump outlet and the damper inlet. Priming the system is achieved in the same way as outlined above, except the syringe is attached to the outlet port of the damper.

Attaching outlet tubing to the outlet port of the damper is achieved in the same way as outlined above. Excessive force in tightening fittings can damage the damper, which is expensive to replace.

Using the Piston Wash system

The use of buffers or solutions which crystallize when exposed to air can lead to abrasion of the piston seal. Optos pumps have a built-in wash chamber. The wash system is designed to flush the back end of the primary piston seal. By using the wash system, you can significantly extend the life of the piston seal (particularly when pumping salt solutions). Your choice of a wash solution depends on the nature of the fluid being pumped (usually a mixture of water with 20% methanol is suggested).

The pump cylinder has two barbed fittings installed. Usually, the lower fitting is used as the wash inlet and the upper fitting is used as the wash outlet. Attach 1/8" ID tubing to the inlet and outlet ports of the wash system. A common means of employing the wash system is to use a syringe attached to the wash outlet tubing to pull fluid into the wash chamber (when fluid comes out the outlet port, you know you have filled the wash chamber). We recommend flushing the wash chamber periodically to minimize piston seal abrasion.. Alternatively, you could deliver fluid continuously through the wash system by circulating the wash solution with a pump.

OPERATION

Basic Operation

Optos pumps perform more reproducibly if there is some degree of backpressure (preferably at least 25 psi). In all cases, outlet resistance must exceed inlet pressure. Otherwise, the fluid will simply flow through the pump without being metered. If the system in which the pump is being used does not generate enough backpressure, we suggest you install a device, e.g., a “dummy” column or a backpressure regulator, to artificially maintain the appropriate backpressure. The ideal setup for the pump is where there is a little positive pressure on the inlet side of the pump (achieved by elevating or pressurizing the reservoir) to minimize cavitation, and substantially greater outlet pressure to maximize valve efficiency.

General Notes on Software Operation

The Optos pumps have intuitive software control. Three separate levels of software control can be accessed. The most common commands, setting the flow rate and the high and low pressure limits, are accessed either from the main display screen, or by pressing the ΔMENU key (the ΔMENU key will cycle through commands for each level of software control). More infrequently used commands are accessed by holding down the DISPLAY key and pressing the ΔMENU key (commands which send the piston to the home position, setting the compressibility compensation factor, setting the refill/output ratio, changing the liquid end type, setting the remote mode, and viewing the EPROM revision). Least frequently used commands are accessed by holding down the ΔMENU key and pressing the DISPLAY key (commands which set the home offset, voltage output, whether the high and low pressure limits will be activated, and the stall stop condition).

The UP and DOWN keys change the setting of the various parameters. When the setting is numeric, the longer the key is held down, the faster the value changes. The DISPLAY key returns to the main display of flow (and pressure when the optional damper is installed).

Setting the Flow Rate

When the power is turned ON, the display shows the set flow rate (and pressure when the optional damper is installed).

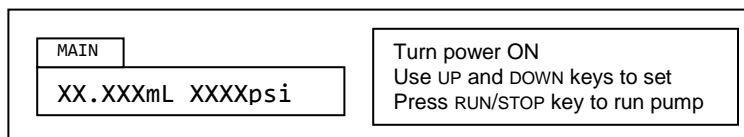

To set the flow rate, press the UP arrow key to increase the flow set point, press the DOWN arrow key to decrease the flow set point. The longer you hold down the up or down arrow, the faster the display scrolls through flow settings. To run the pump at the flow set point, press the RUN/STOP key. The green LED will be illuminated when the pump is running.

Setting the High Pressure Limit

Optos pumps fitted with a pulse damper are able to have high pressure limits set.

The default setting is the maximum pressure capability of the model. To change the setting, press the ΔMENU key once. Use the UP or DOWN arrow key to increase or decrease the high pressure limit. To return to the main screen, press the DISPLAY key.

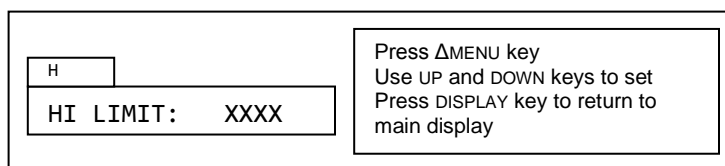

When the high pressure limit is violated, the pump stops running, the lower red LED lights and the display shows HI PRESS XXXX.

Setting the Low Pressure Limit

Optos pumps fitted with a pulse damper are able to have low pressure limits set.

The default setting is the zero psi. The maximum setting is 50 psi less than the high pressure limit. To change the setting, press

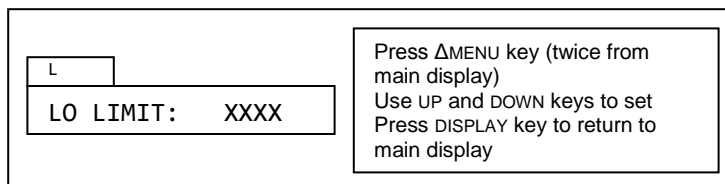

the ΔMENU key twice. Use the UP or DOWN arrow key to increase or decrease the low pressure limit. To return to the main screen, press the DISPLAY key.

When the low pressure limit is violated, the pump stops running, the lower red LED lights and the display shows LO PRESS XXXX.

Configuration Screens

To access the configuration screens, hold the DISPLAY key while pressing the ΔMENU key. To cycle to the next command, press the ΔMENU key.

Setting the Compressibility Compensation Factor

Various fluids have different compressibilities at different pressures. You can adjust for compressibility by setting the compressibility compensation factor. The default setting is 0. The maximum setting is 60. Each increment increases motor speed by approximately 1%.

C

COMPRESS: XX

Hold DISPLAY & press ΔMENU key from main display, press ΔMENU key
Use UP and DOWN keys to set
Press DISPLAY key to return to main display

To change the compressibility compensation factor, hold the DISPLAY key and press the ΔMENU key (from the main display), or, when in the configuration screens press the ΔMENU key to display the “compress” screen. Use the UP or DOWN arrow key to increase or decrease the compressibility compensation factor. To return to the main screen, press the DISPLAY key.

Sending the Piston to the Home Position

The piston can be sent to the fully forward position, useful when changing piston seals.

To send the piston to the forward position, hold the DISPLAY key and press the ΔMENU key (from the main display). Press the RUN key. The motor will drive the piston to the home position. To return to the main screen, press the DISPLAY key.

HP

GO HOME: HIT RUN

Hold DISPLAY & press ΔMENU key from main display
Press RUN to send piston to home (forward) position

Changing the Refill Rate Setup

Optos pumps can be set to a variety of refill:output ratios. The default setting, refill: full out, optimizes the ratio for minimal pulsation throughout the flow rate range, by minimizing the refill portion of the duty cycle. Other settings are:

refill: 15 out: 85 (sets the ratio to 15:85),
refill: 30 out: 70 (sets the ratio to 30:70),
refill: 50 out: 50 (sets the ratio to 50:50),
refill: 70 out: 30 (sets to ratio to 70:30).

R

REFILL: FULL OUT

Hold DISPLAY & press ΔMENU key from main display, press ΔMENU key
Use UP and DOWN keys to set
Press DISPLAY key to return to main display

To change the refill rate, hold the DISPLAY key and press the ΔMENU key (from the main display), or, when in the configuration screens press the ΔMENU key to display the “refill” screen. Use the UP or DOWN arrow key to change the refill:output ratio. To return to the main screen, press the DISPLAY key.

Setting the Liquid End Type (Piston size and Liquid End material)

Optos pumps can have one of several different liquid ends and pistons installed. When shipped from the factory, the setting is for the model purchased.

You may have occasion to wish to change the piston and/or liquid end type to change the flow rate range or material of construction.

To change the liquid end type, hold the DISPLAY key and press the ΔMENU key (from the main display), or, when in the configuration screens press the ΔMENU key to display the “head” screen. Use the UP or DOWN arrow key to change the liquid end type. The numeric field indicates piston size (3/32, 1/8, ¼), and alpha field indicates material of construction of the head (SS, PK). To return to the main screen, press the DISPLAY key. The high and low pressure limits are reset when changing the liquid end type to the default for that type.

LE	
HEAD:	1/8 SS

Hold DISPLAY & press ΔMENU key from main display, press ΔMENU key twice times
Use UP and DOWN keys to set
Press DISPLAY key to return to main display

Setting the Remote Control Setting

Optos pumps can be controlled remotely via an analog signal (either 4-20 mA or 0-5 VDC). If you wish to operate the Optos pump remotely using one of the available analog signals, you need to set the field to that signal (operating via RS232 does not require any setup).

REM	
REMOTE:	OFF

Hold DISPLAY & press ΔMENU key from main display, press ΔMENU key three times
Use UP and DOWN keys to set
Press DISPLAY key to return to main display

To change the remote control setting, hold the DISPLAY key and press the ΔMENU key (from the main display), or, when in the configuration screens press the ΔMENU key to display the “remote” screen. Use the UP or DOWN arrow key to change the remote control setting. To return to the main screen, press the DISPLAY key.

Viewing the EPROM Revision Level

Optos pumps have EPROM software. You can view the version of software installed.

To view the software version, hold the DISPLAY key and press the ΔMENU key (from the main display), or, when in the configuration screens press the ΔMENU key to display the “version” screen. To return to the main screen, press the DISPLAY key.

V	
VERSION:	X.XX

Hold DISPLAY & press ΔMENU key from main display, press ΔMENU key four times
Use UP and DOWN keys to set
Press DISPLAY key to return to main display

Advanced Screens

To access the configuration screens, hold the ΔMENU key while pressing the DISPLAY key. To cycle to the next command, press the ΔMENU key.

Setting the Home Position Offset

The software for speeding up and slowing down the motor is set off the home position sensor location. The software is optimized for running flows with minimal pulse at substantial pressures. If your conditions are different, you may wish to change the home offset setting to minimize pulsation. The default setting is 0. Other settings are from -99 to +99.

HO	
HOME OFFSET:	XX

Hold ΔMENU & press DISPLAY key from main display
Use UP and DOWN keys to set
Press DISPLAY key to return to main display

To change the home position offset setting, hold the Δ MENU key and press the DISPLAY key (from the main display), or, when in the advanced screens press the Δ MENU key to display the “home offset” screen. Use the UP or DOWN arrow key to change the home offset setting. To return to the main screen, press the DISPLAY key.

Setting the Output Function

One of the outputs on the I/O ports is a 0-5V output. This output can be changed between pressure and flow.

To change the output, hold the Δ MENU key and press the DISPLAY key (from the main display), or, when in the advanced screens press the Δ MENU key to display the “output” screen. Use the UP or DOWN arrow key to change the setting (PRESS means the output will correspond to pressure, FLOW means the output will correspond to flow). To return to the main screen, press the DISPLAY key.

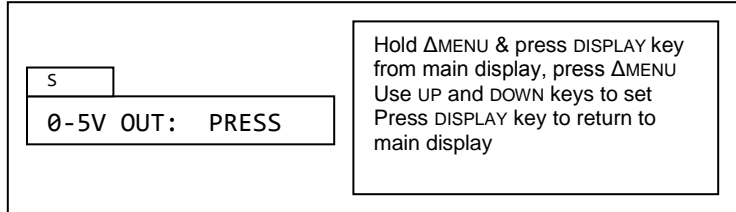

Setting the High/Low Pressure Limit Shutdown

Optos pumps (with the optional damper) can have their high and low pressure limits de-activated. The default setting is ENA (limits are active).

To change the limit setting, hold the Δ MENU key and press the DISPLAY key (from the main display), or, when in the advanced screens press the Δ MENU key to display the “limit” screen. Use the UP or DOWN arrow key to change the limit setting (DIS = limits de-activated; ENA = limits activated). To return to the main screen, press the DISPLAY key.

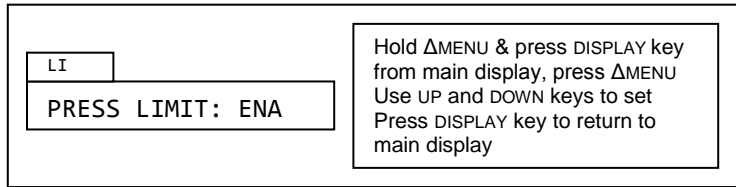

Setting the Motor Stall Shutdown

If Optos pumps are not fitted with the optional damper or if the pressures limits are de-activated, the motor will stall when exposed to excessive pressure. When the stall stop field is set to ON, the pump will stop pumping when a stall condition is noted; when the stall stop field is set to OFF, the pump will continue pumping, or trying to pump even in the presence of a motor stall. The default setting is OFF.

To change the stall setting, hold the Δ MENU key and press the DISPLAY key (from the main display), or, when in the advanced screens press the Δ MENU key to display the “stall” screen. Use the UP or DOWN arrow key to change the limit setting (OFF = pump runs after stall; ON = pump stops after stall). To return to the main screen, press the DISPLAY key.

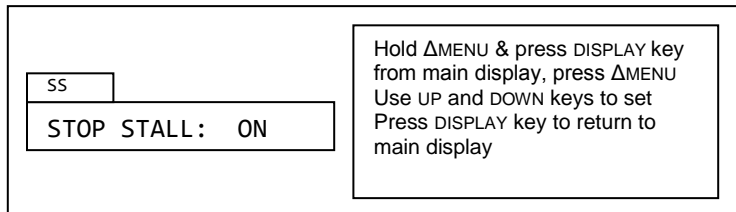

Viewing the Stroke Length

You may view the stroke length of the piston of your pump by holding the MENU key and pressing the DISPLAY key (from the main display), or, when in the advanced screens press the MENU key to display the “stroke” screen. To return to the main screen, press the DISPLAY key.

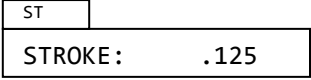

ST
STROKE: .125

Hold ΔMENU & press DISPLAY key from main display, press ΔMENU
Press RUN key to zero
Press DISPLAY key to return to main display

Zeroing the Pressure Transducer

If the Optos pump is fitted with the “Plus” option, a pressure transducer is present in the damper assembly. The pressure transducer is sensitive to temperature changes and can read a pressure when no pressure is present. It is possible to re-zero the pressure transducer.

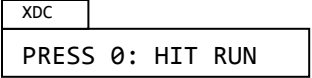

XDC
PRESS 0: HIT RUN

Hold ΔMENU & press DISPLAY key from main display, press ΔMENU
Press RUN key to zero
Press DISPLAY key to return to main display

To zero the pressure transducer, hold the ΔMENU key and press the DISPLAY key (from the main display), or, when in the advanced screens press the ΔMENU key to display the ‘press’ screen. Press the RUN key to zero the transducer. Be sure to do this when there is no pressure on the pump. To return to the main screen, press the DISPLAY key.

Pump Limits

You should note the limits of your Optos pump. Exceeding or violating these limits may damage your pump and will void your warranty.

Viscosity Limits

Liquids with viscosities of 100 centipoise or higher often reduce nominal flow rate values. You cannot pump liquids with viscosities exceeding 500 centipoise.

Chemical Limits

Some buffers, particularly halide salts at high concentrations, can cause corrosion of type 316 stainless steel. If you leave buffers in the pump, crystallization may occur and cause damage to the seal material. Some solvents can swell the plastic material in the valves or the piston seal. Usually, you can substitute less damaging fluids, and you can minimize potential damage by carefully flushing the pump. You can sometimes substitute special materials; please consult with the factory.

Mechanical Limits

Pumped fluids should be free of particulate matter, since clogged valves may result in erratic flow rates. We strongly recommend the use of a filter on the inlet line to protect the valves from small particles. A 10 micron sintered stainless steel filter is available from Eldex (Part No. 5776) and is suitable for most applications. When you need to avoid metal, a 10 micron plastic filter is available from Eldex (Part No. 1279).

Damage to the mechanical parts will result from subjecting the pump to excessive pressure. Do not try to pump fluid against pressures which exceed the maximum pressure capability of your model.

Temperature Limits

Eldex pumps are designed to operate under ambient temperature conditions. If you take appropriate precautions to prevent condensation, you can use the pump in a cold room. Do not use the pump in an environment which exceeds 35°C.

It is possible to pump fluids which are at elevated temperatures. Although the reaction of specific fluids at elevated temperatures to the wetted parts may vary, it is usually the plastic materials in the liquid end which will be of concern. Generally, the CTFE maintains integrity at temperatures up to 200°C. The PTFE piston seal material is generally good to 260°C. You will want to consult the factory when pumping fluids at elevated temperatures if there is any question in your mind about how the wetted parts will react.

Shutdown Procedures

Eldex pumps are manufactured using materials selected to resist corrosion. However, some buffers, most notably halide salts at high concentration, are capable of corroding type 316 stainless steel, and some solvents are capable of distorting CTFE or other plastics used in the pumps. Therefore, it is important to flush the pump after using any potentially damaging materials.

To flush the pump, first pump distilled water to remove any salt(s) or solids. You should do this for a minimum of ten minutes as soon as possible after using the pump. Next, you should flush the pump with an inert solvent such as methanol for at least five minutes.

<p>CAUTION: It is important to note that salts and buffers can lead to corrosion of stainless steel or distortion of plastics if they are left in contact with the pump for long periods of time. Failure to flush potentially corrosive substances from the pump may void your warranty.</p>
--

MAINTENANCE

We have designed Eldex Metering Pumps to give years of trouble-free service. By following a few simple maintenance procedures, you can ensure the longevity of your pump.

Cleaning

Before cleaning your pump, disconnect the pump from the power supply. Cleaning can be accomplished by wiping down with a damp cloth.

Piston Seal

The seal material used is usually a specially formulated PTFE. It is the standard seal material because of its broad range of chemical compatibility, its mechanical properties, and its stability in reciprocating applications.

TIP: We have found, especially with metal-free seals, that “breaking-in” the seals with IPS or methanol for an hour or so, under conditions similar to your expected operating conditions enhances seal life.

The length of service to be expected from any given piston seal depends on a wide variety of factors, including the fluid being pumped and the pressure of the system. It is critically important that the seal be replaced immediately upon failure, or better yet, before failure, because fluid can travel into the mechanical housing of the pump and cause corrosion damage.

When a leak occurs, you may notice fluid just underneath the liquid end. However, a leak may not always be visible, particularly at low flow rates. We suggest you place a wick or litmus paper up the drain slots just underneath the liquid end. You should remove the wick or litmus paper periodically and check for wetness or color changes to see if leakage has occurred.

Piston seal life can often be significantly extended by using the piston wash system integrated in the pump.

Replacing the Piston Seal

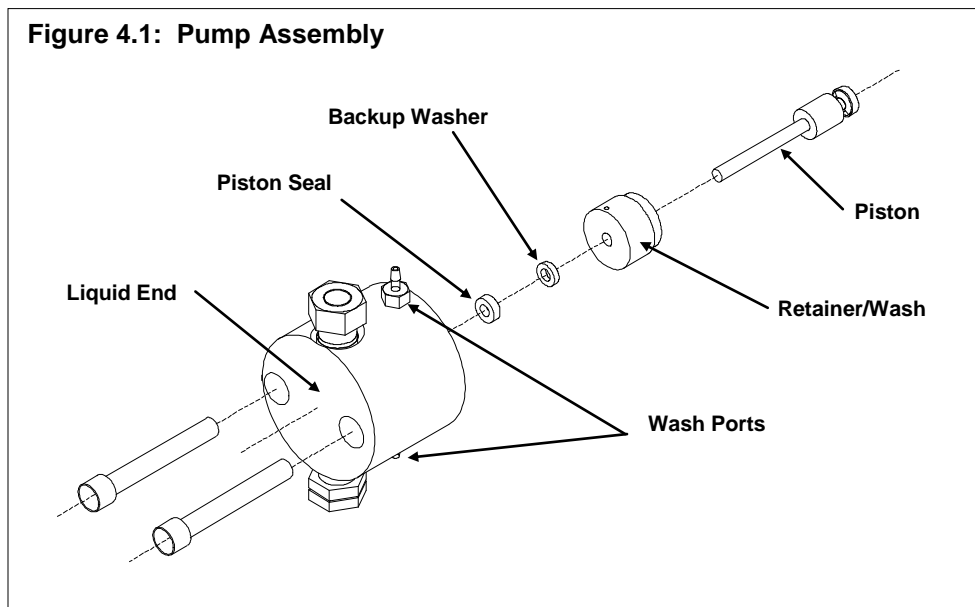

1. Use tools supplied with Part Nos, 5911, (3/32” installation tool and 5/32 hex key); 5941 (installation tool and 5/32 hex key); 5944, (1/4” diameter dowel pin and 5/32 hex key).
2. Send the piston to the home position. Turn the power switch to OFF.
3. Remove the liquid end from the pump as follows: Unscrew the two 5/32” socket head bolts. Pull the liquid end straight out from the pump housing, in line with the axis of the piston. If you cock or tilt the liquid end, you may break the piston. See Figure 4.1.

- Remove the retainer/wash from the liquid end, and insert the installation tool/dowel pin into the liquid end through the piston seal (if your pump uses a 3/32" or 1/8" diameter piston, the installation tool has a "hooked" end, which is used to remove the seals). If you are using the installation tool, hook the existing seals and remove and discard both the washer and the seal. If you are using the 1/4" dowel pin, rock the dowel pin back and forth gently, and remove and discard both the washer and seal. Do not scratch the walls of the piston seal gland in the liquid cylinder with the tool/dowel pin.

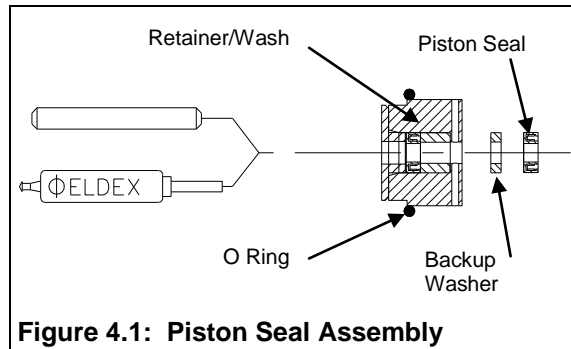

Figure 4.1: Piston Seal Assembly

- Inspect the piston. You can remove the piston by moving the piston up in the slot which holds it in place. If the piston has scratches on the sapphire, or significant corrosion on the stainless steel piston holder, you should replace it. If there is minor corrosion on the piston holder, clean the piston holder. Also inspect for evidence of deposits on the sapphire. If deposits are present on the sapphire (discoloration or particulates), clean it. If the sapphire does not clean, you should replace the piston.
- Inspect the retainer. Clean the retainer/wash if necessary. If there is evidence of wear, or if the piston does not fit snugly in the retainer/wash, or if the retainer/wash grips the piston too tightly, you should replace the retainer/wash.
- Inspect the liquid cylinder, paying special attention to the gland for the piston seal. Any scratches or irregularities will require replacement of the liquid end.
- Clean all parts with a liquid detergent, followed by a rinse. Clean any fluid in the mechanical end of the pump.

- Insert the installation tool/dowel pin into the retainer/wash and then into the new seal backup washer (if present) and new piston seal. When inserting the tool through the new piston seal, the piston seal should lay flat on a hard surface with the spring side down (the seal will generally "snap" onto the tool). Position the parts on the tool in the order shown. Insert the tool into the liquid end bore.
CAUTION: The open side of the seal (side revealing the spring or the O ring) should face the closed (fluid side) end of the liquid end.

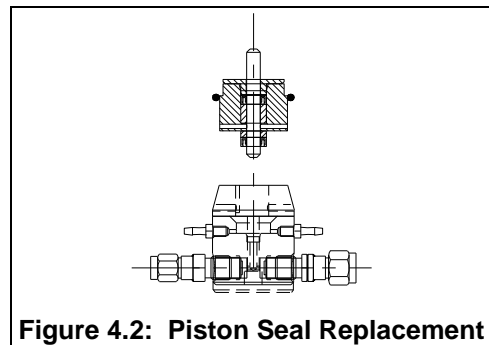

Figure 4.2: Piston Seal Replacement

- Keeping the tool perpendicular with the face of the liquid end, push the piston seal and washer into the liquid end bore, by pressing down gently and evenly on the edge of the retainer/wash with both thumbs.
- Withdraw the tool, while holding the retainer/wash and liquid end firmly in place. When installing the retainer/wash, make sure you line up the holes in the retainer with the wash system.
- Reinstall the liquid end on the pump. See Figure 4.1.

PRECAUTIONS:

- Do not re-use the old piston seal.
- Cleanliness is very important for optimal seal and check valve operation.
- Note suggestion regarding seal "break-in" on page 15.

NOTE: If you retain the tools supplied with Eldex Part Nos. 5911, 5941, or 5944, you can purchase just the seals and re-use the tools.

Replacing Valves

Always replace valves in a clean area to prevent dust and dirt from entering the pump.

Removal of Existing Valves

The valves are the two hexagon-shaped components on the liquid end assembly (see Figure 4.4). Inlet valves can be distinguished from outlet valves by the groove on the hexagonal part of the valve. Remove the valves with a ½” wrench, turning in a counter-clockwise direction. After removal, be careful to keep the valve oriented so the translucent washers face upwards to prevent parts from falling out. If you wish to replace the cartridge in the valve, you may purchase replacement cartridges, which include the cartridge and instructions.

Installation of New Valves

1. Inlet valves can be distinguished from outlet valves by the groove on the hexagonal part of the valve.
2. Unscrew the shipping nut and remove the metal shipping washer, as these are not used for installation of the valves.
3. Insert the new valve into the liquid end assembly and tighten by hand until just finger-tight. Then use a ½” wrench and tighten ¼ turn more. You should tighten valves to the point at which no further leakage occurs, or not more than 4.5 ft./lbs.

OVERTIGHTENING THE VALVES CAN CAUSE THE SAPPHIRE SEATS TO CRACK.

STABILIZE THE VALVE WITH A ½” WRENCH WHEN ATTACHING YOUR FITTINGS TO PREVENT FURTHER VALVE TIGHTENING. DO NOT TIGHTEN FITTINGS TO BEYOND 40 IN./LBS., OR THE POINT WHERE NO FURTHER LEAKAGE OCCURS.

Replacing Valve Cartridges

1. Remove the valve from the cylinder (see above for detailed instructions).
2. Using the smaller dowel pin provided (1-1/4” long by 1/8” diameter), press out the internal components of the valve assembly using a steady pressure. Do not hammer parts through with the dowel pin or hammer on the dowel pin. Do not allow the valve parts to fall out of the valve onto a hard surface.
3. Reassemble the valve by placing the valve insert in the valve housing using the larger (3/16”) dowel pin provided (1373 and 1374 valves use a total of 3 washers, one is installed before installing the valve insert). Make sure it is oriented correctly (see Figure 4.4). Press a CTFE seal into place. Slide the valve cartridge into the valve housing making certain it is oriented correctly. Press another new CTFE seal into place. The CTFE seal will extend approximately 0.020 – 0.030” from the valve housing.
4. Re-install the rebuilt valve into the liquid end assembly and tighten by hand until just finger-tight. Then use a ½” wrench and tighten ¼ turn more. You should tighten valves to the point at which no further leakage occurs, or not more than 4.5 ft./lbs.

Figure 4.4: Liquid End Assembly

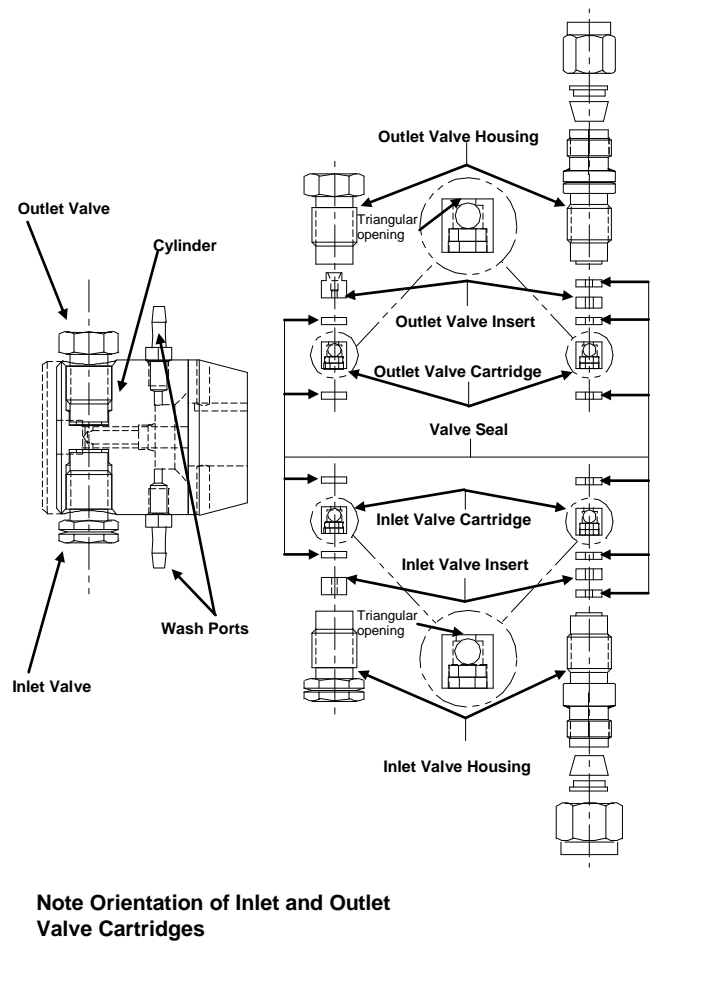

Troubleshooting

Symptom: No flow (probably cause(s) shown in bold)

Question	Answer	Solution
Is the motor turning?	No	Check electrical connections: 1. Is instrument plugged in? 2. Does outlet provide electricity? 3. Is fuse blown? If so, replace.
Is fluid degassed prior to use?	No	Degass fluid prior to use: 1. Boil. 2. Bubble helium through fluid. 3. Subject fluid to a vacuum.
Is fluid filtered?	No	1. Do not pump fluids with suspended particles (a particle as small as ten microns can clog a valve). 2. Install an inlet line filter. 3. Flush with liquid detergent or 20% solution of nitric acid (at max. flow for about 10 minutes), or suck cleaning fluid through pump with a syringe. 4. Ultrasonicate valve assembly.
Is filter clogged?	Yes	Clean filter (clogged filter can create restriction to flow, causing cavitation).
Is mechanical assembly OK?	No	Inspect parts of mechanical assembly; is piston broken?, pushrod frozen in bushing?
Are valves OK?	No	Rebuild or replace valves (excessive force used to tighten fittings to valves or valves to cylinder can cause sapphire seats to crack, chip, or shatter, thereby inhibiting flow).

Symptom: Erratic flow (probable cause(s) shown in bold)

Question	Answer	Solution
What is backpressure on pump	Less than 25 psi	Insufficient backpressure, create more pressure on pump so valves can work properly (install backpressure regulator, or length of small I.D. tubing).
Is fluid degassed prior to use?	No	Degass as per above.
Is fluid filtered?	No	Clean valves as per above, install inlet line filter.
Is filter clogged?	Yes	Clean filter.
Is there a leak at fitting(s)	Yes	Tighten fittings.
Is there a leak at valve connection?	Yes	Tighten valves
Are valves OK?	No	Rebuild or replace valves.

Symptom: Leakage

Question	Answer	Solution
Are seals worn?	Yes	Replace piston seal.

Symptom: Steadily decreasing flow rate

Question	Answer	Solution
Is fluid degassed prior to use?	No	Degas as per above.

Optos SPARE PARTS AND ACCESSORIES

For 3/32" Stainless Steel Pump

<i>Order No.</i>	<i>Description</i>
	Preventive Maintenance Kits
5918	Includes two PTFE piston seals, tools for installation, two valve cartridges, one retainer/wash, a sintered stainless steel filter.
	Piston Seals
5911	Piston seal assembly kit; includes one PTFE seal, and tools for installation.
5912	Piston seal replacement kit; includes two PTFE seals.
5913	Piston seal replacement kit; includes five PTFE seals.
	Valves
1369	Inlet valve assembly, cartridge style, 1/4"-28 fitting.
1372	Outlet valve assembly, cartridge style, 10-32 fitting.
1373	Inlet valve assembly, cartridge style, 1/8" Swagelok® fitting.
1374	Outlet valve assembly, cartridge style, 1/8" Swagelok® fitting.
1371	Inlet valve assembly, cartridge style, 10-32 fitting.
1370	Outlet valve assembly, cartridge style, 1/4"-28 fitting.
1381	Valve cartridge kit (rebuilds one inlet or one outlet valve).
	Piston
5819	1/8" sapphire piston.
	Liquid End Assembly
5902	Includes inlet and outlet valve assemblies, cylinder, piston seals and retainer. Piston not included.
	Fittings
5988	Includes 60 cm of 1/8" Teflon inlet tubing, inlet (1/4-28) and outlet (10-32) tube nuts, and outlet ferrule.
	Filters
5776	10 micron sintered stainless steel filter, with 60 cm long Teflon inlet tube and tube nut.
	Other Parts
5899	Retainer/wash assembly.
	For other parts, consult factory.

For 1/8" Stainless Steel Pump

Order No.	Description
	Preventive Maintenance Kits
5920	Includes two PTFE piston seals, tools for installation, two valve cartridges, one retainer/wash, a sintered stainless steel filter.
	Piston Seals
5941	Piston seal assembly kit; includes one PTFE seal, and tools for installation.
5942	Piston seal replacement kit; includes two PTFE seals.
5943	Piston seal replacement kit; includes five PTFE seals.
	Valves
1369	Inlet valve assembly, cartridge style, 1/4"-28 fitting.
1372	Outlet valve assembly, cartridge style, 10-32 fitting.
1373	Inlet valve assembly, cartridge style, 1/8" Swagelok fitting.
1374	Outlet valve assembly, cartridge style, 1/8" Swagelok fitting.
1371	Inlet valve assembly, cartridge style, 10-32 fitting.
1370	Outlet valve assembly, cartridge style, 1/4"-28 fitting.
1381	Valve cartridge kit (rebuilds one inlet or one outlet valve).
	Piston
5820	1/8" sapphire piston.
	Liquid End Assembly
5903	Includes inlet and outlet valve assemblies, cylinder, piston seals and retainer. Piston not included.
	Fittings
5988	Includes 60 cm of 1/8" Teflon inlet tubing, inlet (1/4-28) and outlet (10-32) tube nuts, and outlet ferrule.
	Filters
5776	10 micron sintered stainless steel filter, with 60 cm long Teflon inlet tube and tube nut.
	Other Parts
5900	Retainer/wash assembly.
	For other parts, consult factory.

For 1/4" Stainless Steel Pump

Order No.	Description
	Preventive Maintenance Kits
5922	Includes two PTFE piston seals, tools for installation, two valve cartridges, one retainer, a sintered stainless steel filter.
	Piston Seals
5944	Piston seal assembly kit; includes PTFE seal, and tools for installation.
5945	Piston seal replacement kit; includes two PTFE seals, no tools..
5946	Piston seal replacement kit; includes five PTFE seals, no tools..
	Valves
1373	Inlet valve assembly, cartridge style, 1/8" Swagelok fitting.
1374	Outlet valve assembly, cartridge style, 1/8" Swagelok fitting.
1381	Valve cartridge kit (rebuilds one inlet or one outlet valve).
	Pistons
5821	1/4" sapphire piston.
	Liquid End Assembly
5904	Includes inlet and outlet valve assemblies, cylinder, piston seals and retainer. Piston not included.
	Other Parts
5901	Retainer/wash assembly.
	For other parts, consult factory.

For 3/32" PEEK Pumps

<i>Order No.</i>	<i>Description</i>
	Preventive Maintenance Kits
5923	Includes two uhmw polyethylene seals, backup washers, tools for installation, two valve cartridges, one retainer, a sintered stainless steel filter.
	Piston Seals
5914	Piston seal assembly kit; includes one uhmw polyethylene seal, and tools for installation.
5915	Piston seal replacement kit; includes two uhmw polyethylene seals.
5916	Piston seal replacement kit; includes five uhmw polyethylene seals.
	Valves
1377	Inlet valve assembly, cartridge style.
1378	Outlet valve assembly, cartridge style.
1383	Valve cartridge kit (rebuilds one inlet or one outlet valve).
	Pistons
5819	1/8" sapphire piston.
	Liquid End Assembly
5905	Includes inlet and outlet valve assemblies, cylinder, piston seals and retainer. Piston not included.
	Fittings
5987	Includes 60 cm of 1/8" Teflon inlet tubing, inlet (1/4-28) and outlet (1/4-28) tube nuts.
	Filters
1279	10 micron plastic filter, with 60 cm long Teflon inlet tube and tube nut.
	Other Parts
5896	Retainer assembly.
	For other parts, consult factory.

For 1/8" PEEK Pumps

Order No.	Description
	Preventive Maintenance Kits
5924	Includes two uhmw polyethylene seals, backup washers, tools for installation, two valve cartridges, one retainer, a 10 micron plastic filter.
	Piston Seals
6007	Piston seal assembly kit; includes one uhmw polyethylene metal-free seal, and tools for installation.
6008	Piston seal replacement kit; includes two uhmw polyethylene metal-free seals.
6009	Piston seal replacement kit; includes five uhmw polyethylene metal-free seals.
	Valves
1377	Inlet valve assembly, cartridge style.
1378	Outlet valve assembly, cartridge style.
1383	Valve cartridge kit (rebuilds one inlet or one outlet valve).
	Pistons
5820	1/8" sapphire piston.
	Liquid End Assembly
5906	Includes inlet and outlet valve assemblies, cylinder, piston seals and retainer. Piston not included.
	Fittings
5987	Includes 60 cm of 1/8" Teflon inlet tubing, inlet (1/4-28) and outlet (1/4-28) tube nuts, and outlet ferrule.
	Filter
1279	10 micron plastic filter, with 60 cm long Teflon inlet tube and tube nut.
	Other Parts
5897	Retainer assembly.
	For other parts, consult factory.

For 1/4" PEEK Pumps

<i>Order No.</i>	<i>Description</i>
	Preventive Maintenance Kits
5925	Includes two uhmw polyethylene seals, backup washers, tools for installation, two valve cartridges, one retainer, a 10 micron plastic filter.
	Piston Seals
6010	Piston seal assembly kit; includes one uhmw polyethylene metal-free seal, and tools for installation.
6011	Piston seal replacement kit; includes two uhmw polyethylene metal-free seals.
6012	Piston seal replacement kit; includes five uhmw polyethylene metal-free seals.
	Valves
1377	Inlet valve assembly, cartridge style.
1378	Outlet valve assembly, cartridge style.
1383	Valve cartridge kit (rebuilds one inlet or one outlet valve).
	Pistons
5821	1/8" sapphire piston.
	Liquid End Assembly
5907	Includes inlet and outlet valve assemblies, cylinder, piston seals and retainer. Piston not included.
	Fittings
5987	Includes 60 cm of 1/8" Teflon inlet tubing, inlet (1/4-28) and outlet (1/4-28) tube nuts, and outlet ferrule.
	Filter
1279	10 micron plastic filter, with 60 cm long Teflon inlet tube and tube nut.
	Other Parts
5898	Retainer assembly.
	For other parts, consult factory.

APPENDIX

RS232

An RS232C modular jack (connector is RJ-11) is on the rear panel. It is configured for 9600 baud, 8 data bits, 1 stop bit, and no parity. Pinout is:

RJ 11 Pin	Function	DB 9 pin
1,6 (white, purple)	Ground	5
2 (black)	DSR (Input)	6
3 (red)	RXD (Input to pump)	2
4 (green)	TXD (Output from pump)	3
5 (yellow)	DTR (Output)	4

The pump uses hardware handshaking. The pump does not transmit on the TXD output if the DSR input is at a low logic level. The pump does not receive on the RXD input when the DTR output is at a low logic level. A low logic level is -3.0 to -15 volts, and a high logic level is 3.0 to 15 volts.

The pump does not send a message except when queried. Each command is characterized by a unique two-letter command code. Only one command can be issued per line. Case is irrelevant. Command strings sent by the pump are terminated by the “/” character.

Command	Response	Default	Minimum	Maximum	Comments
RU	OK/				Sets the pump to the RUN state.
ST	OK/				Sets the pump to the STOP state.
SFxx.xxx	OK/	1.0	Pump specific	Pump specific	Sets the flow rate to xx.xxx mL/min
RF	Okxxxxx/	1.0	Pump specific	Pump specific	Reads the flow rate
ID	Okxyzaaa/				Reads ID of pump where: x = piston diameter (0=.093, 1=.125, 2=.250) y = piston stroke (0=.125, 1=.250, 2=.500) z = pump material (0=ss, 1=pk) Aaa = EPROM revision
RP	OK,xxxx/		0	Pump specific	Reads the pump pressure
SHxxxx	OK/	Pump specific	0	Pump specific	Sets the pump high pressure limit
SLxxxx	OK/	0	0	Pump specific	Sets the pump low pressure limit
RH	Okxxxxx/	Pump specific	0	Pump specific	Reads the pump high pressure limit
RL	Okxxxxx/	0	0	Pump specific	Reads the pump low pressure limit
SC,xxxx	OK/	0	0	60	Sets the pump compressibility compensation
RC	OK,xxxx/	0	0	60	Reads the pump compressibility compensation
SRxx	OK/				Sets the pump refill rate factor
RR	Okxx/				Reads the pump refill rate factor
KD	OK/				Disables keypad (default status at power-up is enabled).
KE	OK/				Enables keypad.
SDx	OK/	1	0	2	Sets the pump piston diameter (0=.093, 1=.125, 2=.250)
RD	Okx/	1	0	2	Reads the pump piston diameter (0=.093, 1=.125, 2=.250)
SSx	OK/	1	0	2	Sets the pump stroke (0=.125, 1=.250, 2=.500)
RS	Okx/	1	0	2	Reads the pump stroke (0=.125, 1=.250, 2=.500)
SMx	OK/	0	0	1	Sets the pump material (0=ss, 1=pk)
RM	Okx/	0	0	1	Reads the pump material (0=ss, 1=pk)
RX	Okxyz/				Reads the pump fault status where: X = motor stall, 0=no fault, 1=fault Y = hi press limit, 0=no fault, 1=fault Z = lo press limit, 0=no fault, 1=fault
SX	OK/				Sets LED to red and stops pump

RI	Okxxxxxxxxx zzzzaaaabbbb ccdefgh/				Xxxxx=pump flow rate Yyyy=pressure Zzzz=high pressure limit Aaaa=low pressure limit Bbbb=compressibility compensation Cc=refill rate factor D=piston diameter (0=.093, 1=.125, 2=.250) E=piston stroke (0=.125, 1=.250, 2=.500) F=pump material (0=ss, 1=pk) G=keyboard status (0=enabled, 1=disabled) H=fault (0=none, 1=motor, 2=high pressure, 3=low pressure)
Z	OK/				Reset Command buffer

Warranty

Eldex products are guaranteed against manufacturing defects for one year from the date of shipment. Parts and labor are both covered under the warranty. Seals, valves, and other disposable items are not included in the warranty. The warranty does not apply when there has been obvious misuse or mistreatment by the user or when damage has been caused by attempted repairs by the user. Exposure of Eldex products to inappropriate chemicals also voids the warranty.

Eldex Laboratories, Inc. will not assume responsibility for contingent liability through alleged failure(s) of its products.

There are no warranties, express or implied, which extend beyond this description. Eldex neither assumes, nor authorizes any person to assume for it, any other liability in connection with the sale and use of the products.

Damages are limited strictly to repair or replacement of the products. Eldex expressly disclaims liability for incidental and consequential damages resulting from the use of the products.

Return Procedure

To return an instrument for repair, contact our factory at (800)969-3533 or (707)224-8800 to obtain authorization. Describe the problem with the instrument to our factory personnel and receive a Return Authorization Number. Reference the number on the outside of the packing box in which you return the instrument. Also reference the Return Authorization Number on any paperwork you send with the unit. Be sure to enclose a brief note describing the problems, reference the serial number of the unit, and describe any chemicals used. Also reference your return address. Send the instrument freight prepaid to:

Eldex Laboratories, Inc.
30 Executive Ct.
Napa, CA 94558-6278

Trademarks

Eldex and ReciPro, Eldex Laboratories, Inc., Teflon, E.I. DuPont de Nemours, Inc.; Swagelok, Swagelok Co.; PEEK, Victrex plc

Eldex reserves the right to incorporate improvements and alter construction details without notice.

